



STATIONARY BAE BATTERIES: Vented Lead Acid (VLA) / Flooded Installation and Operating Instructions



OPzS & OGi Series Batteries











5990002

Important Documents - Do Not Discard

Stationary Vented Lead Acid (VLA) Batteries, Installation and Operating Instructions

This publication defines the essential requirements for the proper storage, handling, assembly, commissioning, operation, and maintenance of the BAE OPzS and OGi stationary vented lead-acid batteries.

1.0 SAFETY PRECAUTIONS & WARNINGS

	<ul style="list-style-type: none"> • Observe operating instructions and position them within sight of the battery! • Work only on batteries under instruction of skilled personnel!
	<ul style="list-style-type: none"> • When working on batteries wear safety glasses and protective clothing! • Comply with accident prevention rules, local safety codes, as well as DIN VDE 0510, VDE 0105 part 1.
	<ul style="list-style-type: none"> • No smoking! Do not expose the battery to an open flame, a glowing fire or sparks as explosion and fire hazards exist.
	<ul style="list-style-type: none"> • Acid splashes on the skin must be flushed with plenty of water. • Acid splashes in eyes must be flushed thoroughly for at least 15 minutes with plenty of water. • Seek medical attention immediately! • Remove clothing exposed to acid and wash with water immediately to avoid additional contact with skin.
	<ul style="list-style-type: none"> • Explosion and fire hazard due to explosive gases escaping from the battery. • Caution! Metal parts of the battery are always live, therefore do not place items or tools on the battery. • Avoid short circuits!
	<ul style="list-style-type: none"> • Caution! The electrolyte (diluted sulfuric acid) is extremely corrosive.
	<ul style="list-style-type: none"> • Caution! Block batteries or cells are heavy! • Ensure secure installation! • Only use suitable transport equipment!
	<ul style="list-style-type: none"> • Dangerous voltages! • Shock hazard!
	<ul style="list-style-type: none"> • Used batteries with this symbol are reusable goods and must be properly recycled. • Used batteries that are not recycled must be disposed of as special waste in accordance with all local, state, and federal regulations.
	

1.1 ELECTROLYTE HAZARDS



The electrolyte is dilute sulfuric acid, which is harmful to skin, and eyes. It is electrically conductive and corrodes unprotected metal surfaces.

PRECAUTIONS

- a) When handling electrolyte wear full eye protection, rubber or plastic gloves, apron and boots.
- b) If electrolyte contacts skin, wash it off immediately with large amounts of water. Remove contaminated clothing.
- c) If it contacts the eyes, thoroughly flush with water and seek immediate medical attention.
- d) Neutralize any spilled acid with a weak alkaline solution of 1 pound of bicarbonate of soda dissolved in 1 gallon of water.

1.2 ELECTRICAL HAZARDS



A filled and charged battery presents a high voltage, high current shock and short circuit hazard.

PRECAUTIONS

Observe standard safety measures when working on batteries:

- a) Remove watches, rings or metal jewelry.
- b) Wear rubber gloves and boots.
- c) Use insulated tools.
- d) Never lay tools or other metallic objects on the battery/cell.
- e) Before working on the system disconnect the charger and load prior to closing and/or opening battery connections. Use appropriate lockout/tag-out procedures.

1.3 EXPLOSIVE GASES



Batteries can generate gases which, when released, can explode, causing blindness and other serious personal injury.

PRECAUTIONS

- a) Always wear protective clothing and use the correct safety tools.
- b) Eliminate any potential of sparks, flames or arcing.
- c) Provide adequate ventilation.

Using the correct tools and wearing the proper safety equipment will help prevent injury should an accident occur.

TABLE OF CONTENTS:

INTRODUCTION	1
1.0 SAFETY PRECAUTIONS & WARNINGS	1
1.1 ELECTROLYTE HAZARDS	2
1.2 ELECTRICAL HAZARDS	2
1.3 EXPLOSIVE GASES	2
TABLE OF CONTENTS	3
2.0 RECEIVING OF STATIONARY BATTERIES	4
2.1 VISIBLE EXTERNAL DAMAGE.....	4
2.2 CONCEALED DAMAGE.....	4
2.3 ACCESSORIES	5
3.0 STORAGE AND MAINTENANCE	5
3.1 STORAGE AND MAINTENANCE: WET CHARGED BATTERIES	5
3.2 STORAGE AND MAINTENANCE: BATTERIES REMOVED FROM OPERATION	5
4.0 UNPACKING & HANDLING	6
4.1 ACCESSORIES	6
5.0 PRE-INSTALLATION PLANNING	6
5.1 RACKS (<i>EXISTING RACK</i>)	7
5.2 RACKS (<i>NEW RACK</i>)	7
6.0 BATTERY CELL/JAR INSTALLATION	7
6.1 TERMINAL PREPARATION	8
6.2 INTER-CELL CONNECTORS	8
6.3 TERMINAL PLATES	9
6.4 FINAL INSTALLATION STEPS.....	9
7.0 COMMISSIONING – SUPPLIED WET AND CHARGED	10
7.0.1 COMMISSIONING WITH FLOAT CHARGE VOLTAGE – 2.23 VPC	11
7.0.2 COMMISSIONING WITH HIGHER CHARGING VOLTAGES – 2.33 TO 2.40 VPC	11
8.0 INSTRUCTIONS FOR OPERATION	11
8.1 FLOAT CHARGING	11
8.2 EQUALIZATION CHARGING	11
8.3 CHARGING CURRENTS	12
8.4 TEMPERATURE-RELATED CHARGING VOLTAGE	12
8.5 OPERATING TEMPERATURE	12
8.6 DISCHARGE CYCLE	12
8.7 RECHARGING CYCLE	13
9.0 BATTERY MAINTENANCE	13
9.1 CLEANING OF BATTERIES	13
9.2 ADDITION OF WATER	13
10.0 PERIODIC INSPECTIONS	14
10.1 TOTAL SYSTEM VOLTAGE AND CURRENT	14
10.2 INDIVIDUAL CELL VOLTAGES	15
10.3 CELL TEMPERATURE	15

10.4	FLOAT CURRENT	15
10.5	SPECIFIC GRAVITY (ELECTROLYTE DENSITY)	15
10.6	CONNECTION RESISTANCE MAINTENANCE READINGS	16
11.0	IN-SERVICE CAPACITY TESTS	16
 SUPPLEMENT A: DRY CHARGED BATTERIES INSTRUCTIONS <i>(Optional – may not be attached)</i>		
SA1.0	STORAGE AND MAINTENANCE: DRY CHARGED BATTERIES	SA-1
SA2.0	FILLING AND FINAL INSTALLATION - FOR DRY CHARGED BATTERIES	SA-1
SA2.1	FILLING WITH SULFURIC ACID – FOR DRY CHARGED BATTERIES	SA-1
SA2.2	FINAL INSTALLATION STEPS	SA-2
SA3.0	COMMISSIONING – DRY CHARGED BATTERIES	SA-3
SA3.1	COMMISSIONING OF DRY CHARGED BATTERIES IN NORMAL CONDITIONS	SA-3
SA3.1.1	COMMISSIONING VIA FLOAT CHARGE VOLTAGE - 2.23 VPC	SA-3
SA3.1.2	COMMISSIONING VIA HIGHER CHARGING VOLTAGES - 2.35 to 2.40 VPC	SA-3
SA3.2	COMMISSIONING OF DRY CHARGED BATTERIES WITH EVIDENCE OF SELF DISCHARGE ...	SA-4
SA3.3	COMMISSIONING OF DRY CHARGED BATTERIES WITH EVIDENCE OF EXCESSIVE SELF DISCHARGE	SA-4
SA3.4	COMPLETION OF COMMISSIONING	SA-5

2.0 RECEIVING OF STATIONARY BATTERIES

Every precaution has been made in packaging the batteries for shipment to assure their safe arrival. IMMEDIATELY upon delivery (while carrier delivering the shipment is still on site) please check the packaging materials for evidence of damage in transit and the Bill of Lading to assure all parts are being delivered, including the accessories.

2.1 VISIBLE EXTERNAL DAMAGE

- Wet acid stains may indicate spillage or leakage of electrolyte on wet supplied cells
- Crushed “Do Not Stack” cones or damaged boxes could be evidence of rough handling during transit and damage to cells.

If any of the above are observed, make a note of it on the bill of lading before signing.

NOTE: Shipping damage must be handled with the carrier -- not BAE Batteries USA

2.2 CONCEALED DAMAGE

It is recommended that the cells be unpacked and checked for concealed damage as soon as possible. Freight carriers generally require that concealed damage be inspected by the carriers representative within 10 days from date of delivery to determine responsibility.

It is the receiving facility’s responsibility to notify the freight carrier of concealed damage.

If cells need to be unpacked, see Section 4.0

2.3 ACCESSORIES

If possible, upon receiving the battery systems, check the accessory packages against the included packing list for contents making certain that all the parts ordered with your system are included.

3.0 STORAGE AND MAINTENANCE

BAE USA supplies lead-acid batteries in a fully charged, ready to use state. Alternatively, the cells may be provided in a dry-charged (unfilled) state for either prolonged storage or export, refer to Supplement A of this manual for dry-charge battery details.

Packaging depends on transit routes (domestic or export) and varies from simple shrink wrapping on a pallet to seaworthy crating for export or special request.

Store batteries indoors in a clean, dry and cool location.

DO NOT stack pallets. Damage may occur and the warranty will be voided.

3.1 STORAGE AND MAINTENANCE: NEW WET CHARGED BATTERIES

Batteries provided filled (wet) and charged may be stored without further charging for a limited period because of self-discharging and related chemical processes.

After a **maximum storage period of 12 weeks at 25°C (77°F) or less (or 6 weeks at ambient temperatures above 25°C (77°F))** the batteries must be charged by connecting to a proper charger providing a continuous float charge of 2.23 volts per cell or providing an equalization (boost) charge to the cells (See Section 8.2). Storage at high temperatures results in accelerated rates of self-discharge and increases the frequency of required boost charging if the cells are not on constant float charge.

Storage times exceeding the above maximums may result in plate sulfation which may adversely affect electrical performance and expected life.

Adequate freeze protection must be met for low temperature storage, as this will damage the battery and cause potentially hazardous leaking. A fully charged battery is more resistant to freezing than a discharged one. As a battery loses charge, its specific gravity decreases causing it to have a higher freezing temperature. The freezing temperature versus specific gravity is shown in the table below. BAE VLA batteries have a specific gravity of 1.240 kg/l at 68°F.

Specific Gravity (68°F)	Freezing point		Specific Gravity (68°F)	Freezing point	
	°C	°F		°C	°F
1.000	0.0	32.0	1.225	-39.8	-39.0
1.150	-15.1	5.0	1.250	-54.3	-65.0
1.175	-20.2	-4.0	1.275	-70.0	-93.0
1.200	-28.0	-18.0	1.300	-71.1	-95.0

3.2 STORAGE AND MAINTENANCE: BATTERIES REMOVED FROM OPERATION

Batteries that have been in service and taken out of operation must be maintained on permanent float charge or must receive a periodic equalize charge not to exceed every 6 weeks at ambient temperatures at 25°C (77°F). Other conditions listed in Sections 3.0 and 3.1 apply. For extended storage periods please contact BAE USA or your local representative for recommendations.

All racks should be properly aligned and all the bolted parts tightened thoroughly before placing the cells on them. Use levelers/shims to compensate for irregularities in the floor surface.

5.1 **RACKS (EXISTING RACK)**

If the cells are to be installed on an existing battery rack, the following inspection should be made prior to installation to avoid any possibility of damage to the new battery.

- a) Inspect all bolted connections to make sure that all are properly aligned and tight.
- b) Check all painted surfaces making sure everything is clean and free of corrosion.
- c) Make sure the rail insulation is clean and in place.
- d) If the existing rack is not designed for the new batteries being installed this could affect your seismic rating and battery warranty. Please contact BAE USA or your local representative with questions.

If deficiencies are found with the existing rack - DO NOT INSTALL THE NEW CELLS UNTIL CORRECTIVE ACTIONS ARE TAKEN.

If your inspection indicates that no corrective action is required, proceed with the cell/jar installation (go to Section 6.0).

5.2 **RACKS (NEW RACK)**

Carefully unpack rack materials using care not to scratch the coated surfaces. Check received parts against the Bill of Materials for the individual rack. If you find damage to the rack components, file a claim against the carrier.

NOTE: If rack specific spill containment systems are used, then their installation will likely have to be done while installing the rack. Refer to the manufacturer's recommended installation procedures.

Refer to the rack assembly drawing and installation instructions and proceed with rack assembly.

- When assembled, battery racks must be level and in conformance with the rack manufacture's drawings and specifications supplied with the equipment. This will ensure that neither individual cells nor rack assembly can topple, twist or overturn. Use levelers to compensate for irregularities in the floor surface.
- Do not place battery cells on the rack until the rack has been completely assembled with all bolts having been tightened. Otherwise, the weight of the cells may cause the rack to shift and collapse.
- Never remove or loosen braces from a loaded battery rack, removal of braces could allow the rack to shift or collapse.

If the new rack is not designed for the new batteries being installed this could affect your seismic rating and battery warranty. Please contact BAE USA or your local representative with questions.

6.0 BATTERY CELL/JAR INSTALLATION

SAFTEY REMINDERS – see Section 1 for details:



The electrolyte is dilute sulfuric acid, which is harmful to skin, and eyes. It is electrically conductive and corrodes unprotected metal surfaces.



A filled and charged battery presents a high voltage, high current shock and short circuit hazard.



Batteries can generate gases which, when released, can explode, causing blindness and other serious personal injury.

To position the cells on the rack special auxiliary equipment, such as lifting straps (Section 4.0) or other mechanical lifting gear, may be required. If necessary, this equipment may be obtained from BAE Batteries USA.

An alignment guide should be used to aid in placing the cells properly on the rack. Properly aligned cells will aid in connecting the cells together.

It is recommended that cell installation begin in the middle of the bottom tier with the distance between the cells being determined from the center of the rack. In this way, it is possible to make allowances toward the end of the rack(s). Planning the layout based on cell dimensions and spacing ahead of time will prevent having to move cells on the rack later.

Standard spacing between battery cells is 10 mm (0.394 in).

For a seismic rated rack, if cell spacers have been included, install the spacers between the cells during placement of each cell, otherwise, insufficient spacing will be left to insert them later. Install the remaining seismic battery rails for these racks once all cells are in the proper position.

Note for 6V Block –N6/N7 individual cell raised terminal battery installations only:

6V Block –N6/N7 batteries come with the inter-cell connectors pre-installed by the factory. As such, each battery string will have two different installed connector configurations – an “A” configuration and a “B” configuration. This allows the jars to use shorter straight across connectors instead of longer diagonal connectors.

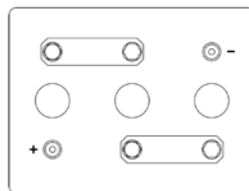

“A” 6V Block Configuration

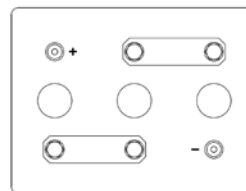

“B” 6V Block Configuration

6.1 TERMINAL PREPARATION

Prior to assembling the inter-cell connectors to the cells, the plastic post covers should be removed and the post contact surfaces should thoroughly cleaned by using the provided wire brush and a clean cloth.

NOTE: Caution should be taken when using the wire brush as not to make contact with other exposed metal areas to prevent short circuits.

Once clean, the post contact surfaces should have a light layer of no-ox grease applied. These steps will insure the very best possible connection surface; once these surface preparation steps are completed the connector to cell assembly can be performed.

6.2 INTER-CELL CONNECTORS

The individual cells are connected by either using the included thermoplastic-insulated copper connectors or the lead plated copper connectors (type is dependent on cell type and customer preference). The connectors are bolted to the threaded insert post using either a stainless steel M10 Allen head bolt or a 17 mm hex head bolt (bolt type is dependent on cell type).

All bolted connections should be made using a calibrated torque wrench to insure proper tightness of the connection without causing any damage to the battery posts. The torque settings for both of BAE bolt types (M10 Allen and 17mm Hex) is:

- **22 Newton-meters or 195 (194.7 actual) inch-pounds.**

6.3 TERMINAL PLATES

For multi-terminal cell strings, terminal plate assemblies are provided standard for the +/- customer connection cells. For single terminal cell strings the terminal plates are purchased as an optional item. The standard terminal plates allow for customer connection with either single hole or 2-hole 3/8" lugs with 1" spacing.

These terminal plate assemblies are to be bolted together using the following torques for the terminal plate/bracket connection and the bracket to battery post connection. Terminal plate covers are included as part of the terminal plate kit for safety.

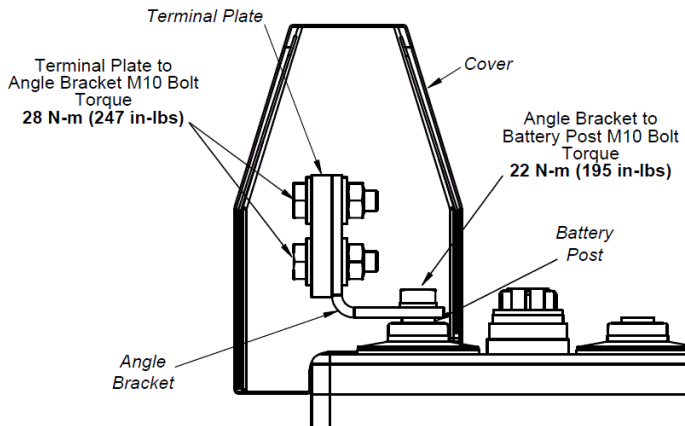

Connection Type	Torque setting for BAE SS Hardware N-m (in-lbs)
Angle Bracket to Battery Post	22 N-m (195 in-lbs)
Terminal Plate to Angle Bracket	28 N-m (247 in-lbs)

If the cells were received Dry Charged (unfilled), go to Supplement A, Section SA2.0, Filling and Final Installation – for Dry Charged Batteries.

6.4 FINAL INSTALLATION STEPS

Once the cells have been installed and the connections completed, the following items should be completed.

- Clean the battery room with all installation debris being removed.
- Although already done during unpacking, check the electrolyte level in each cell or block to assure spillage has not happened during handling and installation. The

electrolyte level should be between the maximum and minimum level lines on the container. If for any reason electrolyte was lost during installation, contact BAE USA or your local representative.

- Once the battery room has been cleaned, all of the cells should be wiped down and cleaned using a damp cloth – dampen the cloth with clear (distilled) water. See Section 9.1 on cleaning of cells.

NOTE: *DO NOT use cleaners or chemicals to clean the cells without prior written approval from BAE.*

- Once the cells have been thoroughly cleaned, apply the supplied cell numbering stickers to the upper left or right hand corner of the face of the cells as desired.
 - Please note the cells should always be numbered from the most positive cell to the most negative cell.
- Apply the provided polarity labels as appropriate to the most positive and most negative cell in the system.
- Following IEEE 484 guidelines BAE recommends measuring and recording connection resistance readings to verify connection integrity and to provide a baseline of each connection. Recommendations for how to measure these readings is contained in the IEEE 484 guideline document, but all connection resistance readings must be measured directly off the battery posts.
 - Measure and record inter-cell connection resistances. This value verifies the adequacy of initial installation and provides a reference for future maintenance testing.
 - Review the records of each connection-resistance measurement, separated by connection type (i.e., inter-cell, inter-tier, inter-rack). Compute a separate average for each connection type. The calculated average must be within BAE specification for the connection type.
 - Identify connections if the measured resistance is the greater of 1.1 x the average resistance of each connection type, or the average resistance for the connection type plus 5 micro-ohms. Unmake, clean, and remake the identified connections and re-measure the identified connection resistances.
- Ensure the proper warning and safety signs are present and installed properly for the battery room.
- Additionally please ensure the proper Personal Protection Equipment (PPE), spill containment or cleanup kit and eyewash are present within the battery room as required per the local or national codes. Please contact your local BAE representative if any of these items are needed for your installation.

7.0 COMMISSIONING - SUPPLIED WET AND CHARGED

Prior to starting the charge, make sure to check the tightness of the terminal connections and verify the proper polarity on each cell. Remember, the charger positive connection must be connected to the battery positive terminal. **DO NOT APPLY CHARGE TO THE BATTERIES YET.**

Before applying any charge to the batteries the following steps must be completed:

- If not already installed, install all flame arrestor vents onto cells. The arrestor vents will be a fixed or funnel flip top style. Do not charge cells with shipping caps installed.
- Measure and record the Open Circuit Voltage (OCV) of each cell and ambient temperature. The extent the batteries have discharged during storage determines the commissioning process for the cells.
 - If OCV is $\geq 2.075\text{V}$, then the float charge commissioning process will be used as defined in 7.0.1
 - If OCV is $< 2.075\text{V}$ but $\geq 2.065\text{V}$, then a higher boost charge as defined in 7.0.2 will be required
 - If OCV is $< 2.065\text{V}$ contact BAE USA or your local representative.

Once the pre-commissioning charge measurements are completed, the commissioning charge can begin. Use the process as determined by the OCV measurements above.

7.0.1 COMMISSIONING WITH FLOAT CHARGE VOLTAGE – 2.23 VPC

Place the batteries into service on float charge at 2.23 VPC. After a period of 24 hours the batteries should be in a fully charged condition.

Although not necessary for initial commissioning, some users have standard commissioning processes with a 24 to 72 hour equalize charge for their strings prior to placing them into service. This equalize charge will not harm the battery.

7.0.2 COMMISSIONING WITH HIGHER CHARGING VOLTAGES - 2.33 to 2.40 VPC

Place the batteries into service on equalize charge at 2.33 to 2.40 VPC. After a period of 24 to 72 hours the batteries should be in a fully charged condition.

Once the commissioning charge is completed, measure and record the electrolyte specific gravity and temperature of each cell. A proper range hydrometer and thermometer are included with the standard BAE battery accessories. The following is the nominal acid density (Specific Gravity) at the maximum electrolyte level at a fully charged condition:

Single Cell Nominal Specific Gravity and Tolerance for the BAE OGi and OPzS Cells:

1.240 \pm 0.01 kg/l at 25°C (77°F); yielding a range of 1.230 to 1.250 kg/l

Note that the level of electrolyte in the cell will affect the reading – see Section 10.5 for details.

Once the commissioning charge and electrolyte readings are completed, if the electrolyte levels are not at the maximum level, you may top off cells to the maximum level with purified or distilled water.

8.0 INSTRUCTIONS FOR OPERATION

This section provides the operating instructions and detailed behavior of the BAE VLA lead-acid of batteries.

The instructions for operation and maintenance contained in subsequent sections should be combined or may be supplemented by site specific detailed procedures for necessary testing and inspections. Special testing may be required under certain conditions (DIN, VDE, and KTA for export) and IEEE for domestic applications as set forth by the user.

8.1 FLOAT CHARGING

BAE Stationary lead-acid storage batteries are designed so that optimum life and available capacity are achieved with a float voltage of 2.23 VPC +/- 1% between 10°C (50°F) and 30°C (86°F).

Total string float voltage will be 2.23 V x number of cells +/-1% nominal.

Higher or lower charging voltages can be detrimental as overcharging or undercharging will reduce the batteries life expectancy.

8.2 EQUALIZATION CHARGING

After deep discharges, or inadequate recharging, equalizing charging is necessary. This may be carried out as follows:

- a) At an increased voltage of (2.33 to 2.40 V) x number of cells up to a maximum of 72 hours.
- b) At currents according to the Section 8.3 Charging Currents below

Because it is possible to exceed the permitted load voltages, appropriate measures must be taken, e.g. switch off the load.

If the maximum temperature of 45°C (113°F) is exceeded, the charging must be stopped or switched to float charge to allow the temperature to drop.

The equalize charge is completed when the single cell voltages and electrolyte densities do not increase for two consecutive hours.

Lower equalize voltages increase the equalize duration but decrease the gas emissions generated.

8.3 CHARGING CURRENTS

The charging current on the BAE cells does not need to be limited until the battery voltage has reached 2.40 VPC x number of cells - thereafter the charging current has to be limited to 5A per 100 Ah of battery capacity.

8.4 TEMPERATURE-RELATED CHARGING VOLTAGE

A temperature-related adjustment of the charging voltage within monthly averaged battery temperatures of 10°C (50°F) to 30°C (86°F) is not necessary.

For temperatures below 10°C (50°F) in the monthly average the charging voltage should be increased by 0.005 volts per 1°C (1.8°F).

For temperatures above 30°C (86°F) in the monthly average the charging voltage should be decreased by 0.004 volts per 1°C (1.8°F) to reduce water decomposition and corrosion.

Most standard chargers sold today have temperature compensation capabilities to manage the charge voltage. See individual charger specs for capability and verify that it is active.

8.5 OPERATING TEMPERATURE

All nominal data for BAE stationary batteries is stated based on an operating temperature of 25°C (77°F), the recommended operating temperature range for the BAE cells is 10°C

(50°F) to 30°C (86°F). To maximize life and performance the ideal operating temperature range is 20°C (68°F) to 25°C (77°F).

Higher constant temperatures will reduce the anticipated life expectancy of the battery due to the increase in the corrosion rate of the cell plates. For example, an increase in temperature of 8.4°C (15°F) over the 25°C (77°F) norm would double the corrosion rate, thus this reduces battery life to 50% of the normal life expectancy. A further increase of 16.7°C (30°F) over the 25°C (77°F) norm would further reduce the service life to 25% of the normal life expectancy.

NOTE: At no time should the cell electrolyte temperature ever exceed 55°C (131°F) as permanent battery cell damage will result.

8.6 DISCHARGE CYCLE

A battery is discharged either when the discharge duty cycle is performed when the AC voltage supply fails or when battery capacity tests are conducted on the system. When setting up routine maintenance procedures that include in-service capacity tests, it should be noted that frequent boost charge/discharge cycles could reduce the service life of the battery.

NOTE: It is important not to over discharge a storage battery. Reference the data sheet or battery discharge table for the specific values. These values must not be exceeded.

8.7 RECHARGING CYCLE

Fully discharged and/or partially discharged batteries must not be allowed to remain in a discharged state for longer than 24 hrs, as damage may occur. Therefore, it is necessary to begin recharging immediately after a battery has been discharged. If sufficient time is available to re-charge, use the charger float mode set at 2.23 VPC.

The specific gravity when measured above the plates may not be an accurate indication of battery state of charge after a discharge, as complete mixing of the electrolyte may take up to 3 months. This will not affect the battery's function so long as the individual cell voltages are 2.23 V +.10/ -.05 volts and the battery charge current has returned to normal float level.

If a complete recharge is to be accomplished within a shortened time period, it will be necessary to charge at a higher voltage. (See equalization charging Section 8.2)

9.0 BATTERY MAINTENANCE

Proper maintenance will prolong the life of a battery and will aid in ensuring it is capable of satisfying its performance requirements. A good battery maintenance program will also serve as a valuable aid in determining the need for battery replacement.

9.1 CLEANING OF BATTERIES

Batteries should be kept clean and dry at all times. Cell containers and cell covers are made of plastic materials and should be cleaned with water. No solvents or detergents should be used. Use caution to avoid electrostatic discharges.

In certain circumstances, specific cleaners may be used. However, you must consult with BAE USA or your local representative prior to use. If approved, after application of the cleaner the cell should be rinsed with water and thoroughly dried with a clean damp cloth.

9.2 ADDITION OF WATER

Water must be added to any cell when the electrolyte level has dropped to the minimum level line. Add water to the maximum level line.

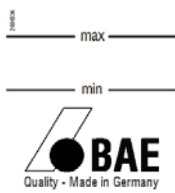

Under normal operating conditions, addition of water becomes necessary typically at intervals of 2 to 5 years depending on the cell model.

If operating temperatures exceed 25°C (77°F) or the battery is subjected to frequent recharging at high voltages, more frequent water additions may be necessary.

NOTE: Use only approved purified or distilled water for topping off the cells.

Required table of impurities for purified water for adding to cells:			
No	Impurity	Max mg/L	
1	Evaporation residue	10	
2	Oxidable organic substances, calculated as KMnO ₄ -consumption.	20	
3	Metals of the hydrogen sulphide group (Pb, Sb, As, Sn, Bi, Cu, Cd)	Per element	0.1
		Together	0.5
4	Metals of the ammonium sulphide group (Fe, Co, Ni, Mn, Cr)	Per element	0.1
		Together	0.5
5	Halogens calculated as chloride	0.5	
6	Nitrogen in the form of nitrate	2	
7	Nitrogen in other form, e.g. ammonium	40	

10.0 PERIODIC INSPECTIONS

The inspections described below should be performed and will serve as a means of checking the reliability of the battery system. The periodic inspections listed below are the minimum required. For additional guidance on recommended battery maintenance, reference IEEE 450.

To be measured and recorded Quarterly:

- Battery System Voltage & Current (Section 10.1)
- Visual inspections:
 - General Appearance & Cleanliness
 - Electrolyte Level
 - Visible Cell damage
- Charger output and voltage
- Ambient temperature and condition of ventilation equipment
- Monitoring equipment operation if installed.

To be measured and recorded every 6 months:

- Quarterly Inspections & Measurements, plus the following
 - Pilot individual cell/block voltages (Section 10.2)
 - Pilot cell temperatures (Section 10.3)
 - Float Current (Section 10.4) or Pilot cell Specific Gravity (Section 10.5)

To be measured and recorded every 12 months (Annually):

- Quarterly Inspections & Measurements, plus the following:
 - Individual cell/block voltages (Section 10.2)
 - Individual cell/block temperatures of all cells/blocks (Section 10.3)
 - Float Current (Section 10.4) or Individual cell Specific Gravity (Section 10.5)
 - Connection resistance readings (Section 10.6)
 - Rack condition and integrity

10.1 TOTAL SYSTEM VOLTAGE AND CURRENT

The total battery voltage at the terminal posts (positive and negative) during float charge should be 2.23 VPC times the number of cells.

Example: 2.23 VPC X 60 cells = 133.8 Total Battery Voltage

Check and record this overall voltage every quarter. If a deviation in voltage greater than +/- 1% is found, then check the charger and make necessary adjustments.

Also, check and record the input current to the batteries every quarter. Consult the specific battery product data sheet for acceptable values.

10.2 INDIVIDUAL CELL VOLTAGES

Pilot cell voltages must be taken and recorded on a 6 month basis. All of the individual cell voltages must be checked and recorded at least once per year.

Single Cell Voltage Tolerance is +0.1 or -0.05V as compared to the nominal voltage of 2.23; this gives us a range of 2.18 to 2.33 volts

If the individual cell voltages are not within the allowable tolerances, measure and record the specific gravity readings of those cells and contact BAE USA or your local representative.

10.3 CELL TEMPERATURE

Cell temperatures must be measured and recorded either off the battery post or with the specific gravity (Section 10.5).

10.4 FLOAT CURRENT

If float current is used to determine state of charge in lieu of specific gravity, it is important that this value be measured accurately. Float current of a fully charged cell under normal conditions is typically 15 to 30 mA per 100 Ah of capacity therefore the measuring device used must be capable of that level of accuracy.

10.5 SPECIFIC GRAVITY (ELECTROLYTE DENSITY)

If accurate float current cannot be measured, then specific gravities must be measured and recorded per above periodic maintenance schedule (Section 10.0)

NOTE: Proper operation of BAE Stationary lead-acid batteries requires a fully charged condition. The following are the nominal electrolyte densities (Specific Gravity) at the maximum electrolyte level in a fully charged condition:

Single Cell Nominal Specific Gravity and Tolerance for the BAE OGi and OPzS Cells:

1.240 ±0.01 kg/l at 25°C (77°F); yielding a range of 1.230 to 1.250 kg/l

For the correct evaluation of the measured electrolyte density, it should be noted that specific gravity is greatly affected by service conditions, including:

- Temperature: Extreme high temperatures reduce electrolyte density; low temperatures increase the density. The change in density is 0.006 kg/l for every 10°C (18°F).
- Electrolyte Level: Electrolyte densities increase proportionally to the water consumption and the lowering of the electrolyte level.
- Insufficient mixing: If water is added to the cells, this will result in lower specific gravity readings above the plates. If the battery is discharged, significant time may be required for full mixing to occur.

If the specific gravity of one cell or if isolated cells are below the specified tolerance, please contact BAE USA or your local representative.

10.6 **CONNECTION RESISTANCE MAINTENANCE READINGS**

It is very important that the procedure for taking connection resistance readings be consistent for each periodic reading so as to detect upward changes that could be caused by corrosion or loose connections. Variations in taking the readings will cause discrepancies in the results. Increased resistance is a cause for concern and may require corrective action.

Normal connection resistance varies with the cell size and connection type. The following methods should be used to establish a connection resistance limit, which should initiate corrective action prior to the next inspection:

- Baseline values are established by measuring the connections after initial installation or after cleaning the connections (see Section 6.4).
 - A 20% increase from the established baseline value for any connection type (i.e., inter-cell, inter-tier, inter-rack) serves as the criteria for initiating corrective action prior to going onto the next inspection.
- Baseline average values are specific to each connection (inter-cell, inter-tier, or inter-rack) and not an average of all connections.
- The timing of the corrective action for increased connection resistance should be determined by an analysis of the effects of the increased resistance. Consult BAE USA or your local representative if there are questions.
- Whenever all battery connections are cleaned and reassembled, a new baseline should be established.
- If the baseline information for an installed battery is unknown, then a baseline should be established when all connections are cleaned and reassembled. When establishing a new baseline, refer to IEEE 450 for guidance.

Please note that no regular re-torque is recommended or required. If regular re-torque is part of your standard maintenance program, consult BAE USA or your local representative.

11.0 IN-SERVICE CAPACITY TESTS

Regularly scheduled capacity tests are not necessary for healthy batteries. However, for batteries approaching end of life or for other specific reasons, capacity tests may be desired. These capacity tests should be conducted in the following manner.

At least 3 days but not more than 7 days before a battery capacity test, give the battery an equalizing charge as described in Section 8.2.

11.0.1 Discharge should be performed with a constant current or constant power type load unit. In determining the correct current or power rate for the capacity test, it is helpful to take into account operating conditions and specific site requirements. From this, select a discharge time and current or power that best fits the requirements. These values are obtained from the BAE discharge sheets for the given battery model.

11.0.2 Prior to starting the discharge test, care must be taken to ensure that the battery is in a fully charged condition. The recommended battery temperature per IEEE 450 should be between 18°C (64°F) and 32°C (90°F).

11.0.3 The capacity test may be performed after the battery has been taken off of float charge. During the discharge the current must not fluctuate more than $\pm 1\%$ on an average from the nominal value. Short-term deviations up to $\pm 5\%$ from the nominal value are allowable for a maximum of 20 seconds.

11.0.4 Voltages at the terminals of all individual cells must be checked after 10%, 25%, 50%, 80% and 100% of the specific discharge period. These should be recorded into a time versus voltage chart; making sure that the final discharge voltages are recorded.

11.0.5 The final discharge voltage of a battery is obtained by multiplying the final discharge voltage of the individual cells by the total number cells. The minimum allowable final discharge voltage is dependent on the discharge current. The rated discharge current values to a specific end point voltage per cell can be obtained from the BAE data sheets.

Example: 1.75 VPC X 60 cells = 105 Total Battery Voltage

11.0.6 The capacity test must be terminated when the discharged time assigned to the specific current has been reached or when the final discharge voltage at the end terminals has been reached. During this operation, the individual cell voltages may be 0.2V below the allowable final discharge voltage.

11.0.7 The measured capacity is the product of the discharge current and the discharge time. If the initial temperature was not 25°C (77°F) the measured capacity must be corrected to compensate, please reference IEEE 450 or contact BAE USA or your local representative.

11.0.8 If the target capacity is not achieved, we request that you contact BAE USA or your local representative. It is generally recommended that if the measured capacity of the battery is less than 80% the battery should be considered for replacement.

11.0.9 Recharge the battery in accordance with the charging procedure as previously stated in the operating instructions immediately after the capacity test.



Stationary VLA Batteries, Installation and Operation Instructions

Please reference IEEE 450 for additional guidance

For any situation not covered in these instructions, please contact BAE Batteries USA or your local representative immediately for guidance.

Any data, descriptions or specifications presented herein are subject to revision by BAE Batteries USA without notice.

BAE Batteries USA
484 County Road V V
Somerset WI 54025
TEL (715) 247-2262
FAX (715) 247-5741
www.baebatteriesusa.com